

6406H MANUAL SUPPLEMENT ELECTRICAL

THE SUPPLEMENT APPLIES TO FM CRANES USING THE OMNEX CONTROL SYSTEM. THE INFORMATION IN THIS SUPPLEMENT SUPERCEDES THE INFORMATION IN THE OWNERS MANUAL.

6406H MANUAL SUPPLEMENT ELECTRICAL

ELECTRICAL SCHEMATIC – 366379000

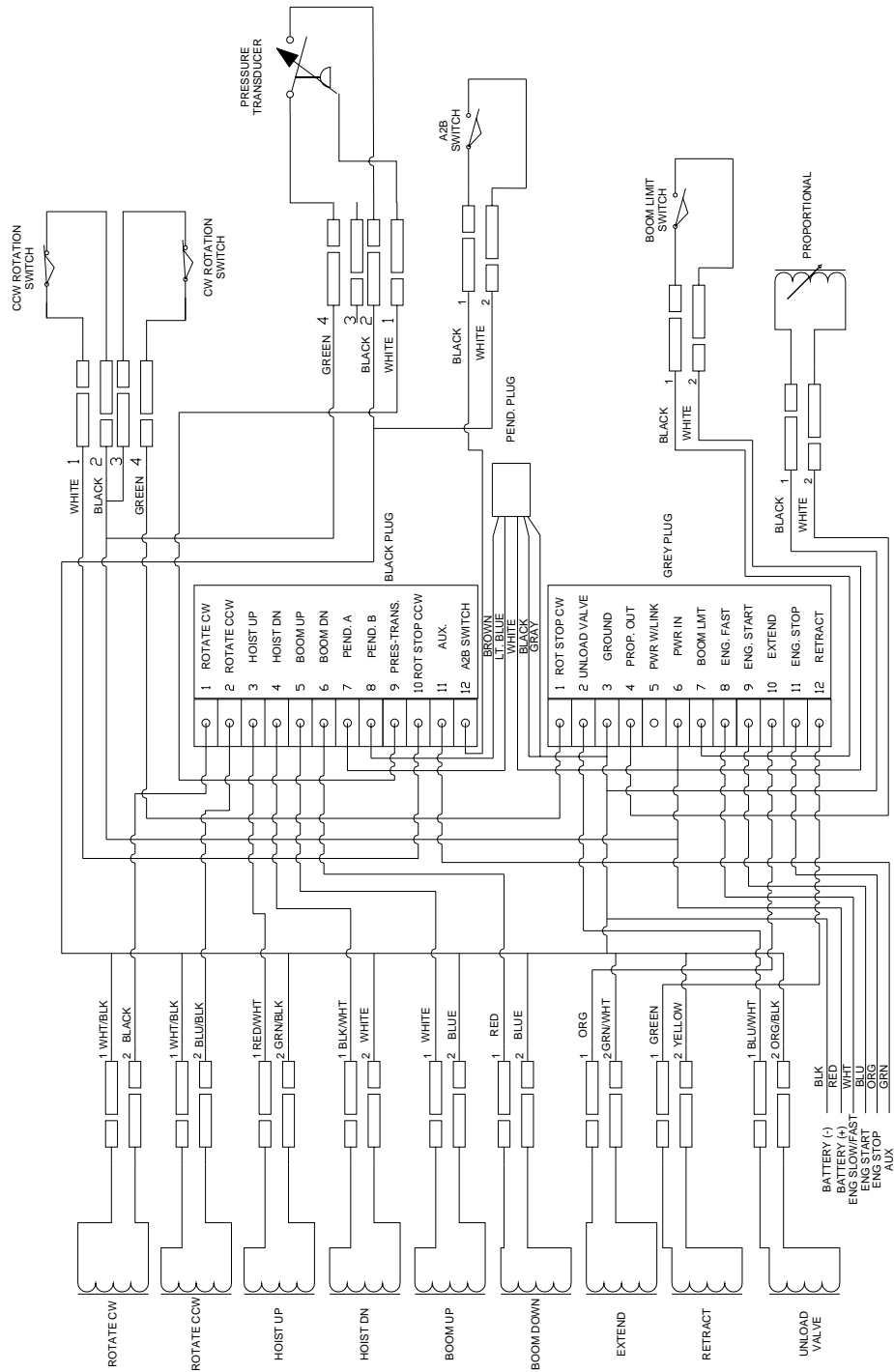

6406H MANUAL SUPPLEMENT ELECTRICAL

MAIN WIRING HARNESS - P/N: 361102000

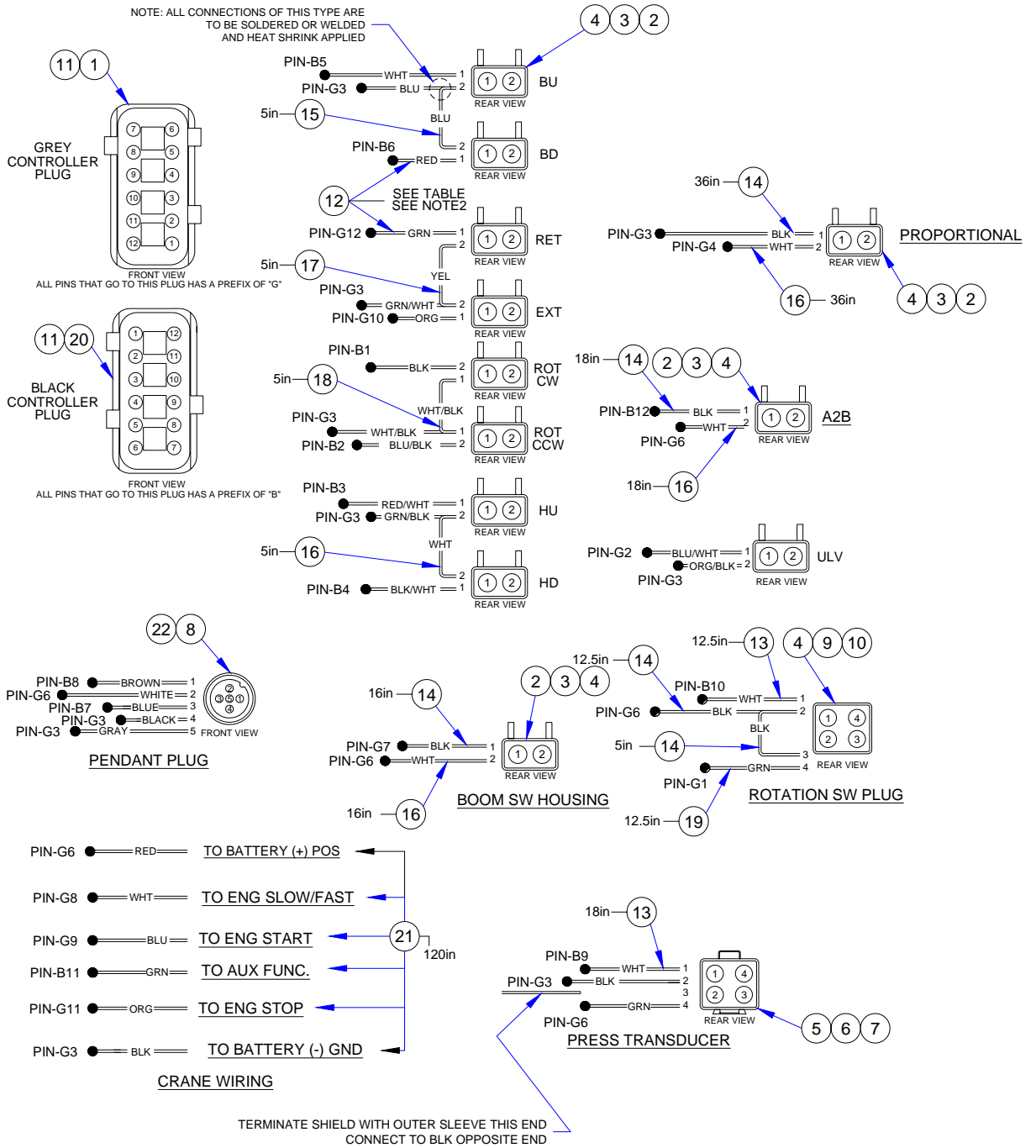

6406H MANUAL SUPPLEMENT ELECTRICAL

ITEM NO.	QTY.	PART NO.	DESCRIPTION
1	1	680163000	HOUSING DEUTSCH 12-PIN (GRAY)
2	12	366367001	HOUSING DEUTSCH CONNECTOR
3	12	366367002	WEDGE DEUTSCH PLUG 2-PIN
4	28	366367003	CONTACT DEUTSCH CONNECTOR (SOCKET)
5	1	366376001	HOUSING DEUTSCH RECEPTACLE 4-PIN
6	1	366376002	WEDGE DEUTSCH 4-PIN
7	4	366376003	CONTACT DEUTSCH CONNECTOR (PIN)
8	1	680164000	RECEPTACLE, PENDANT PLUG
9	1	320931002	WEDGE DEUTSCH PLUG 4-PIN
10	1	320931001	HOUSING DEUTSCH PLUG 4-PIN
11	24	680163001	CONTACT DEUTSCH CONNECTOR (SOCKET)
12	36 in	800633000	CABLE 16 GA 14 COND
13	18 in	750038000	CABLE 18 GA 4 COND SHIELDED
14	87.5 in	800590000	WIRE 16 GA 1 COND BLACK
15	5 in	800594000	WIRE 16 GA 1 COND BLUE
16	105.5 in	800592000	WIRE 16 GA 1 COND WHITE
17	5 in	800596000	WIRE 16 GA 1 COND YELLOW
18	5 in	800603000	WIRE 16 GA 1 COND WHITE W/BLACK
19	12.5 in	800595000	WIRE 16 GA 1 COND GREEN
20	1	680163002	HOUSING DEUTSCH 12-PIN (BLACK)
21	120 in	800629000	CABLE 16 GA 6 COND
22	1	680164001	COVER, PENDANT PLUG RECEPTACLE